

Taksim Maksem Camii

Titanyum inko Kaplama



Şehrizar Konakları / ALTUNİZEDE - İSTANBUL



Menzil Külliyesi / ADIYAMAN



Merkad-ı Şerif / MENZİL - ADIYAMAN



Ahi Evran Külliyesi / KIRŞEHİR



Harikalar Diyarı - Sürengen Barınağı / KAYSERİ



Hacı Derviş Camii / DİKMEN - ANKARA



Nihal Atakaş Camii / İSKENDERUN - HATAY



Kervansaray Apartmanı / HARBIYE - İSTANBUL



Seyit Burhanettin Camii / AKYURT - ANKARA



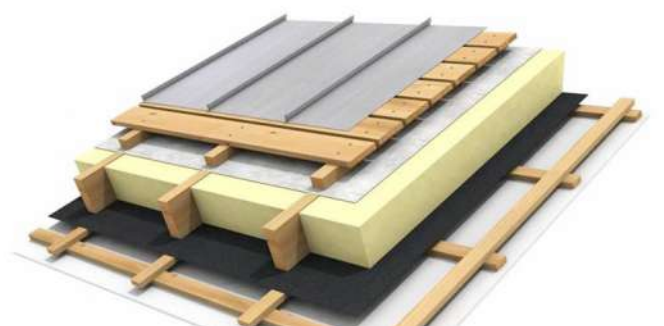

Taraklı Termal / ADAPAZARI

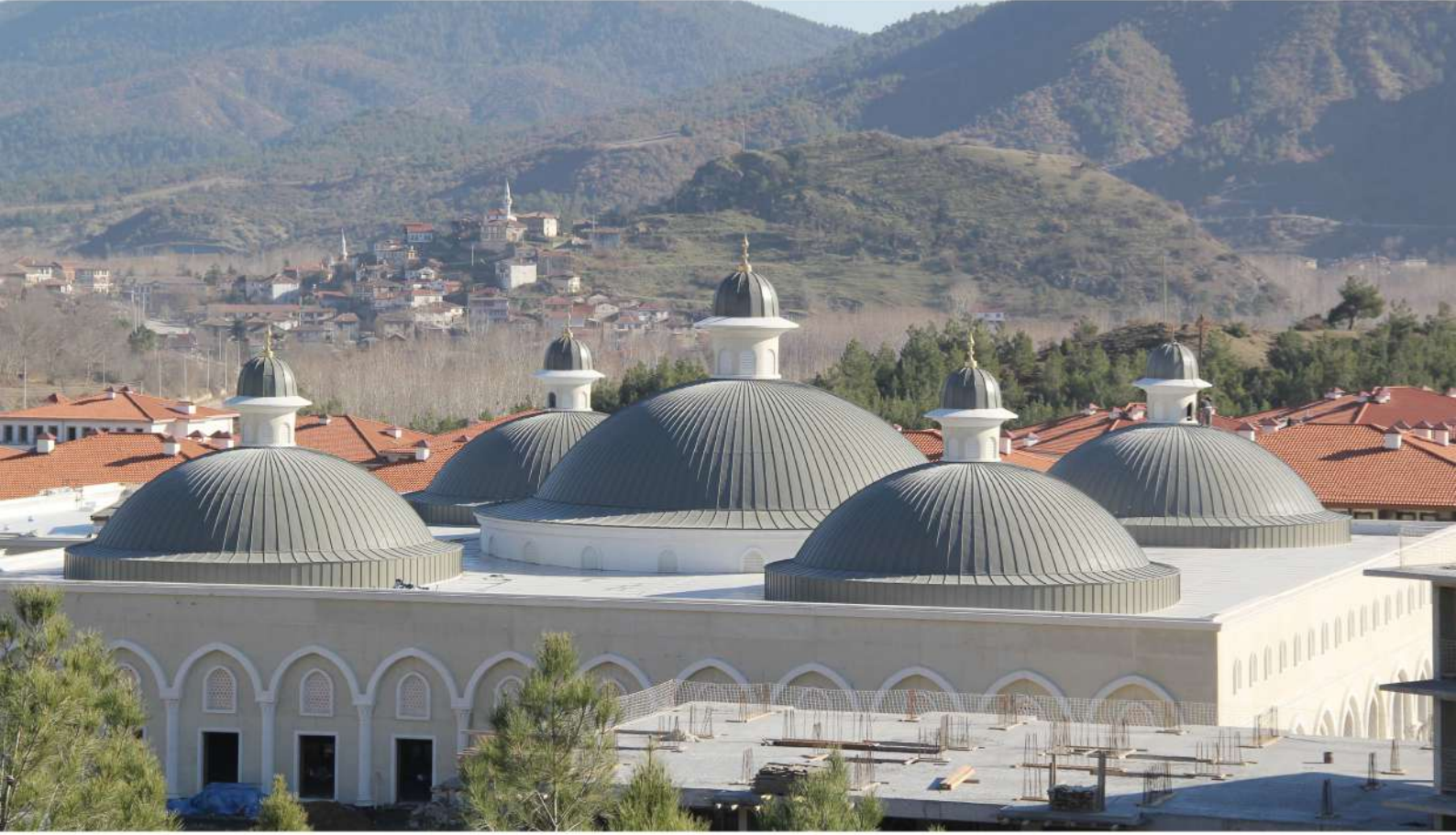



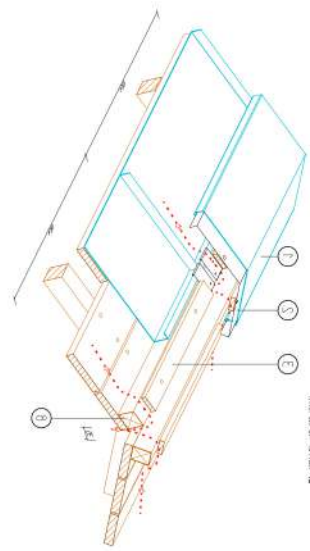
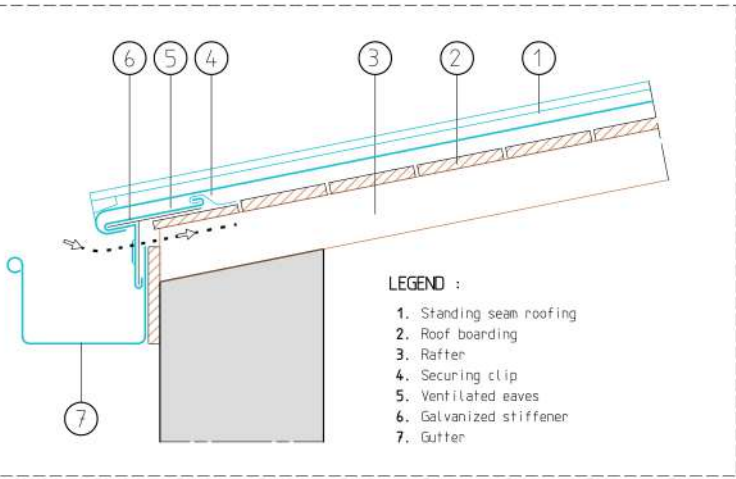

1. Standing seam roofing
 2. Roof boarding
 3. Rafter
 4. Securing clip
 5. Ventilated eaves
 6. Galvanized stiffener
 7. Gutter

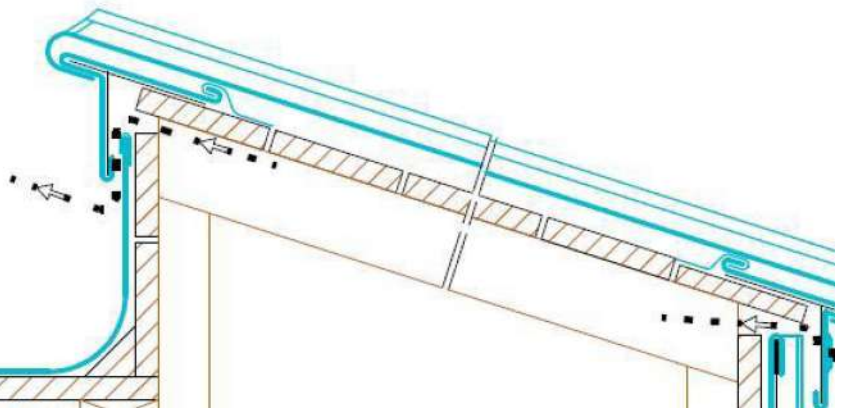
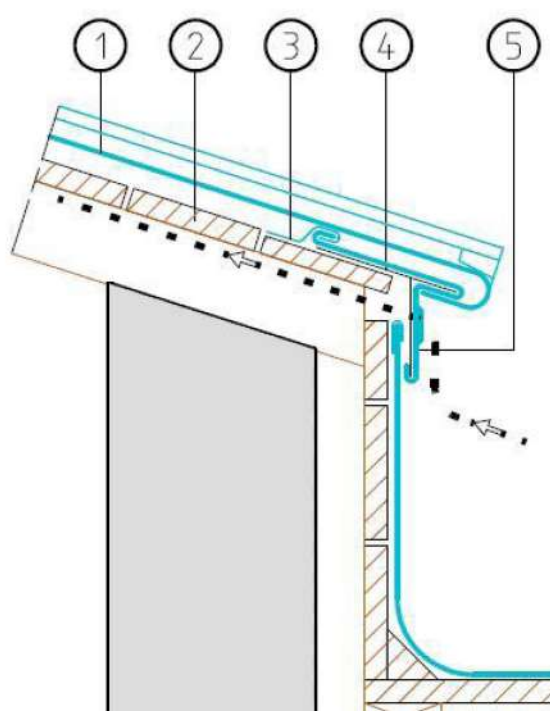
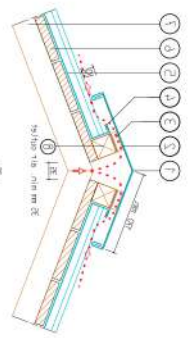
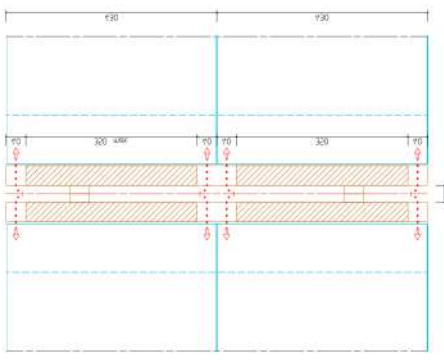
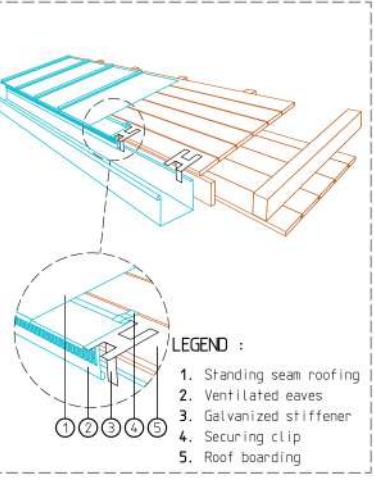

Eczacı Başı Orman Ada Villaları Titanyum Çinko Kaplama



Pearle Mosque KATAR



مشروع بناء مسجد حمد بن جاسم بن جبر آل ثاني
رقم البناء 1
Hamad Bin Jassim Bin Jaber Al Thani
Mosque Construction



المشروع
المشرفة للتعمير
UNITED DEVELOPMENT CO.

حارة التصميم الهندسي
DARA ENGINEERING CONSULTANTS

مشرف المشروع
المشرفة الهندسية
المشرفة والهندسة
مؤسسة قطر للتربية والعلوم وتنمية المجتمع
QATAR FOUNDATION FOR EDUCATION, SCIENCE AND COMMUNITY DEVELOPMENT